

# Caja para extintores (Serie 70)









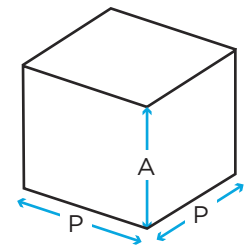

Datos técnicos



Selecciona su color, sustituye 'X' con unos de siguientes:

B: ● E: ● R: ● A: ●



	Opciones de colores	A x L x P (mm)	Peso (kg)	Extintore (kg)	Acceso	Etiquetas
JBW <b>X</b> 70	● ● ● ●	700 x 320 x 255	4	6	Pestillo de plástico	    
JBK <b>X</b> 70	● ● ● ●	700 x 300 x 255			Ventanilla rompible	    

# Caja para extintores (Serie 70)

Datos técnicos

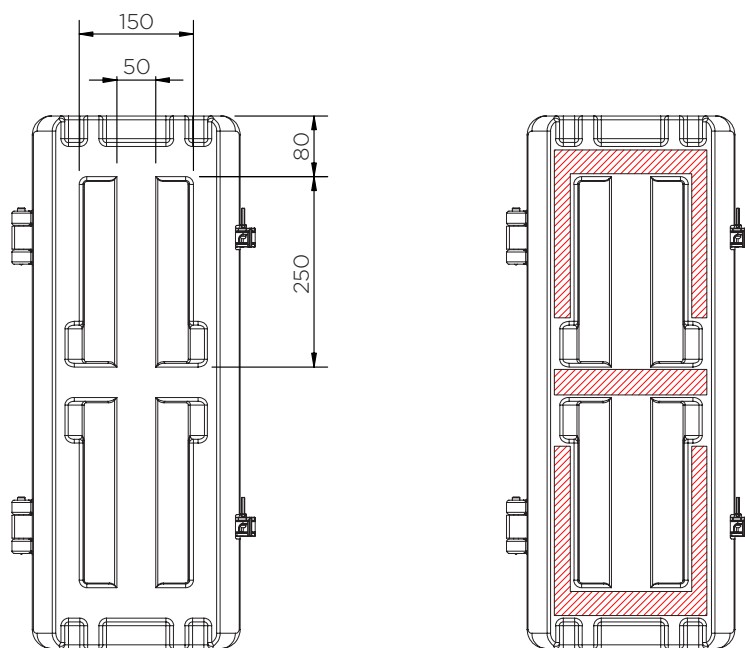
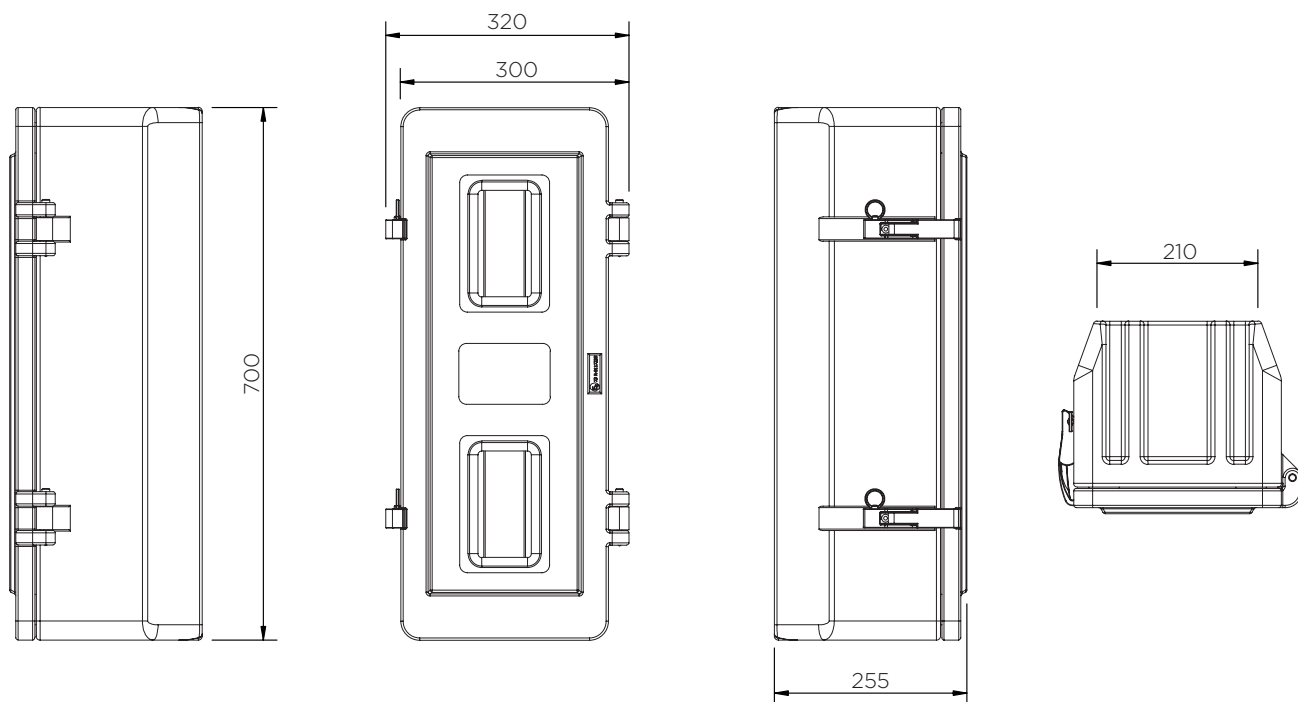

 Superficie apta montarse

# Caja para extintores (Serie 70)

Datos técnicos

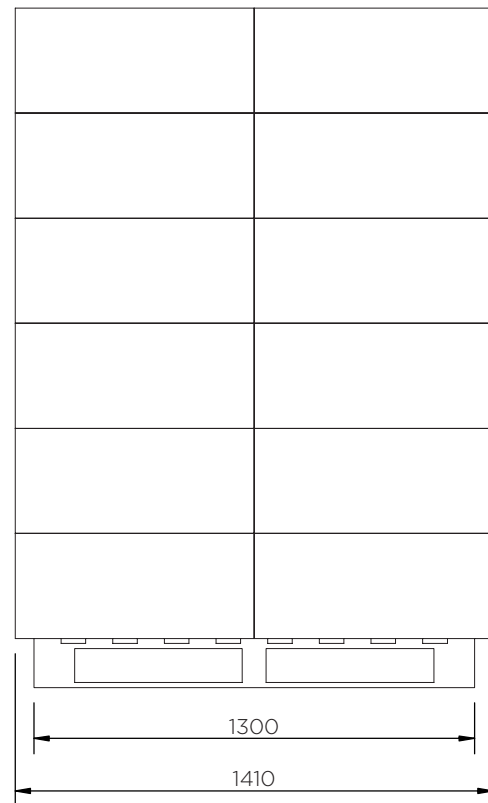
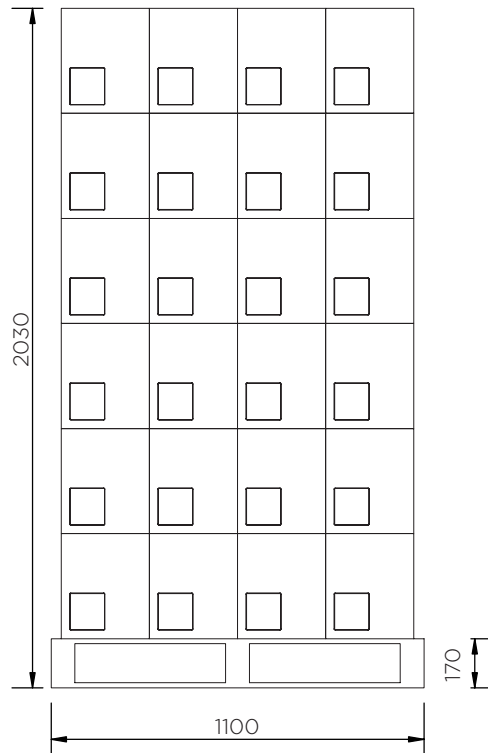

## JBWx70

Piezas por palé	48
20' container	384
40' high cube container	768
Remolque de 13.6 m	864

El Contenido es, a nuestro leal saber y entender, fidedigno y exacto pero todas las recomendaciones y sugerencias no son objeto de ninguna garantía.